

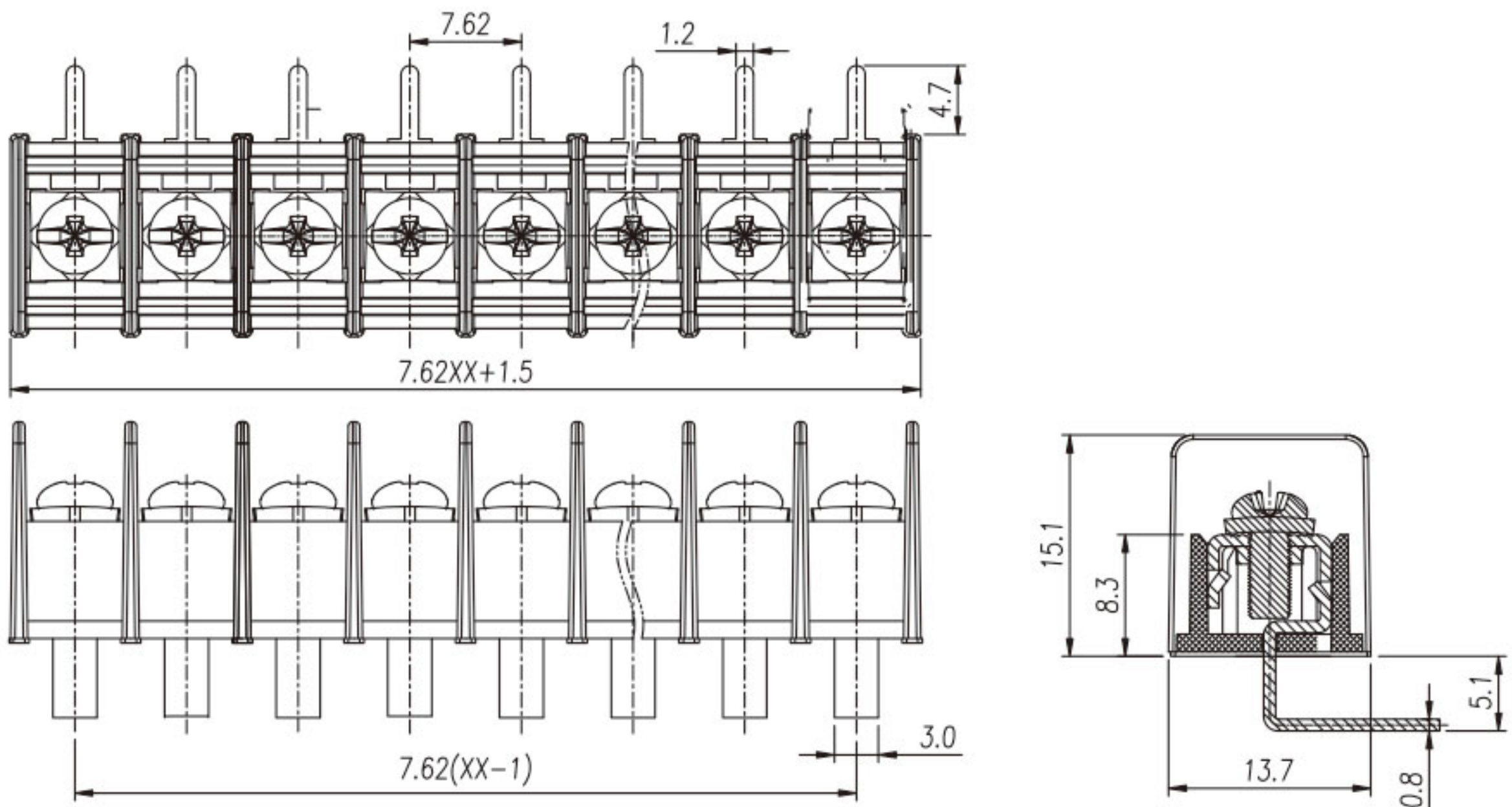

MODEL: JL25R



MATERIAL

Screws	M3.0 Steel Ni plated
Pin Header	Brass, Sn plated
Housing	PA66, UL94V-0

ELECTRICAL

Standard	UL	IEC
Rated voltage	300V	250V
Rated current	15A	24A
Wire range	22-14AWG	2.5mm ²
Contact Resistance	20mΩ	
Insulation resistance	500MΩ/DC500V	
Withstanding voltage	AC2000V/1Min	
Temp. range	-40°C~+105°C	
Torque	5.10kgf-cm/0.5Nm/4.43Lbin	