

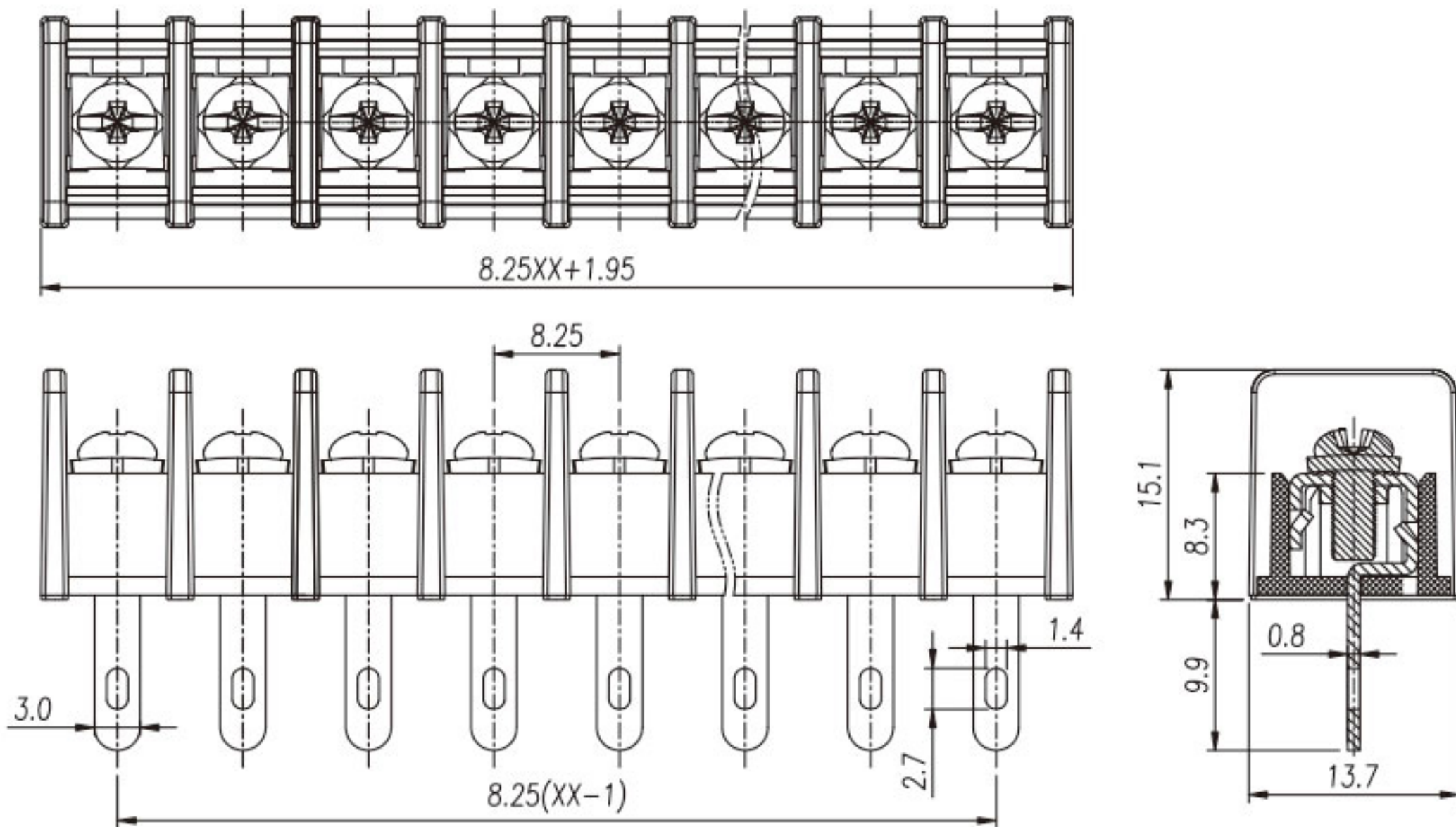

MODEL:JL35H



材质及电镀

螺丝	M3.0, 钢, 镀镍
焊脚	黄铜, 镀锡
塑件	PA66, UL94V-0

电气性能

参考标准	UL	IEC
额定电压	300V	250V
额定电流	15A	24A
使用线径	22-14AWG	2.5mm ²
接触电阻	20mΩ	
绝缘电阻	500MΩ/DC500V	
耐电压	AC2000V/1Min	
温度范围	-40°C~+105°C	
扭矩	5.10kgf-cm/0.5Nm/4.43Lbin	