

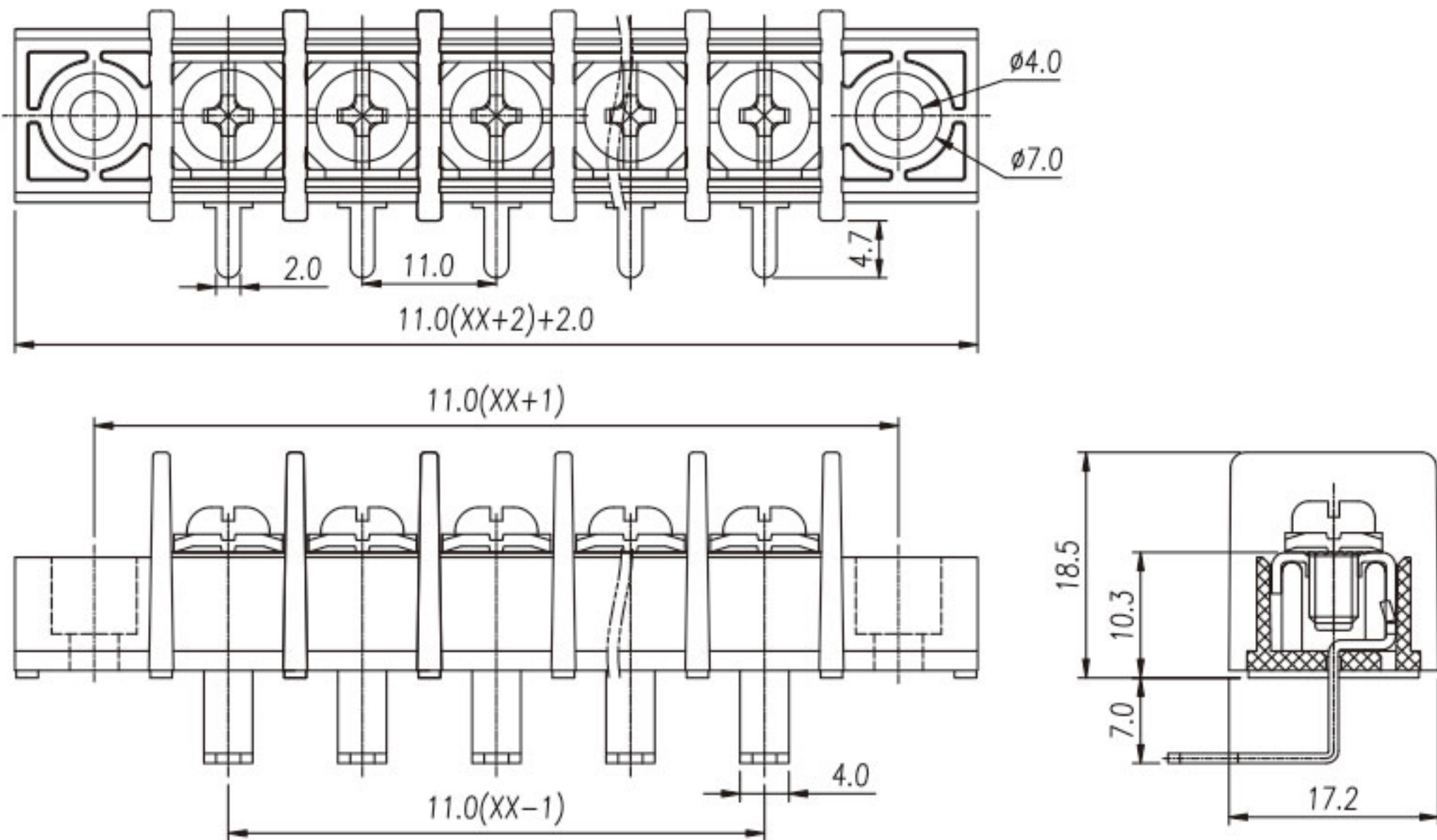

MODEL:JL65RM



MATERIAL

Screws	M4.0 Steel Ni plated
Pin Header	Brass, Sn plated
Housing	PA66, UL94V-0

ELECTRICAL

Standard	UL	IEC
Rated voltage	300V	750V
Rated current	20A	32A
Wire range	22-12AWG	4.0mm ²
Contact Resistance	20mΩ	
Insulation resistance	500MΩ/DC500V	
Withstanding voltage	AC2000V/1Min	
Temp. range	-40°C~+105°C	
Torque	12.24kgf-cm/1.2Nm/10.6Lbin	