

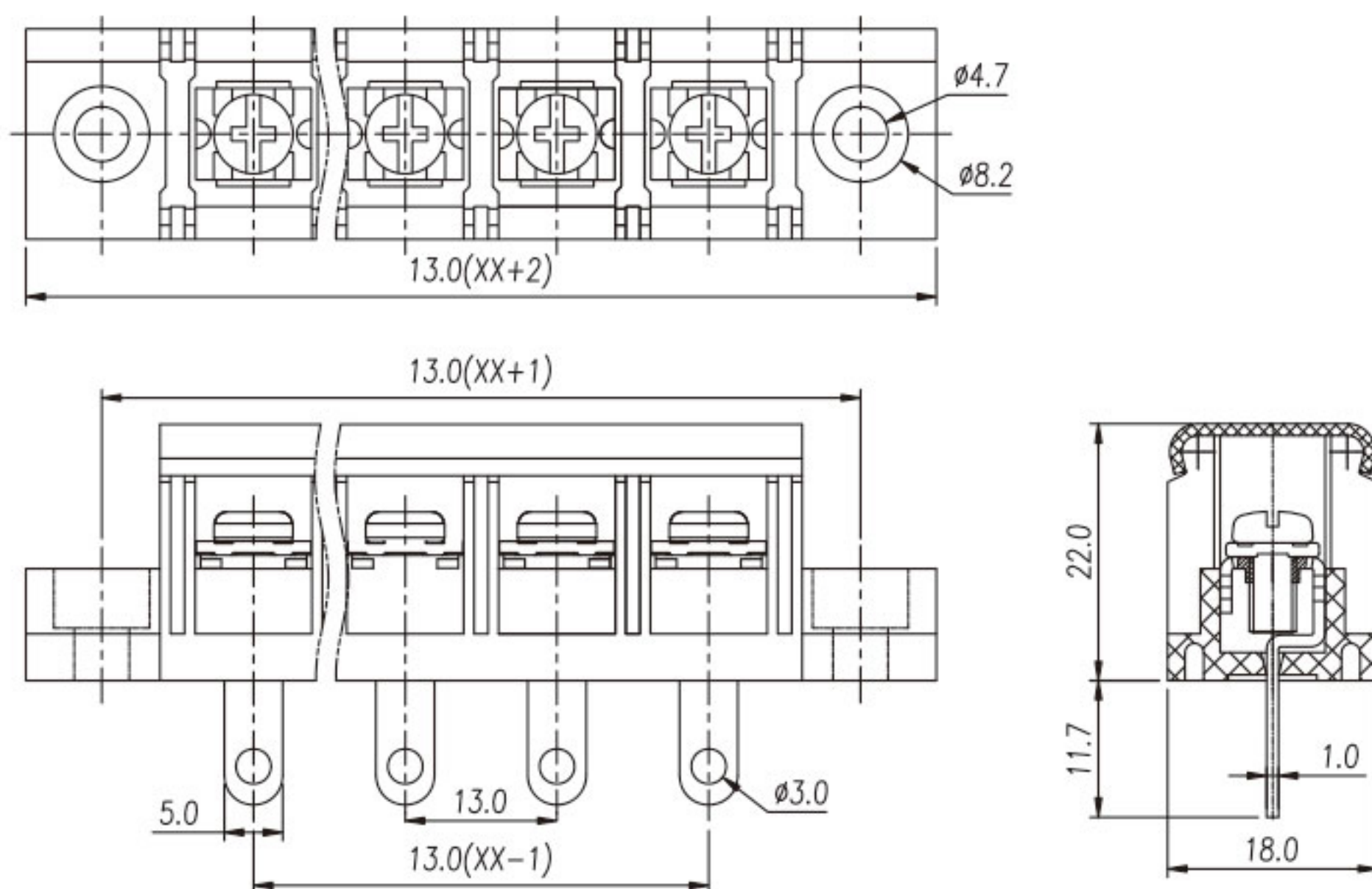

# MODEL:JL78HM



## 材质及电镀

螺丝	M4.0, 钢, 镀镍
焊脚	黄铜, 镀锡
塑件	PA66, UL94V-0

## 电气性能

参考标准	UL	IEC
额定电压	600V	750V
额定电流	40A	41A
使用线径	18-10AWG	6.0mm <sup>2</sup>
接触电阻	20mΩ	
绝缘电阻	500MΩ/DC500V	
耐电压	AC2000V/1Min	
温度范围	-40°C~+105°C	
扭矩	12.24kgf-cm/1.2Nm/10.6Lbin	