

MODEL:JL78RM

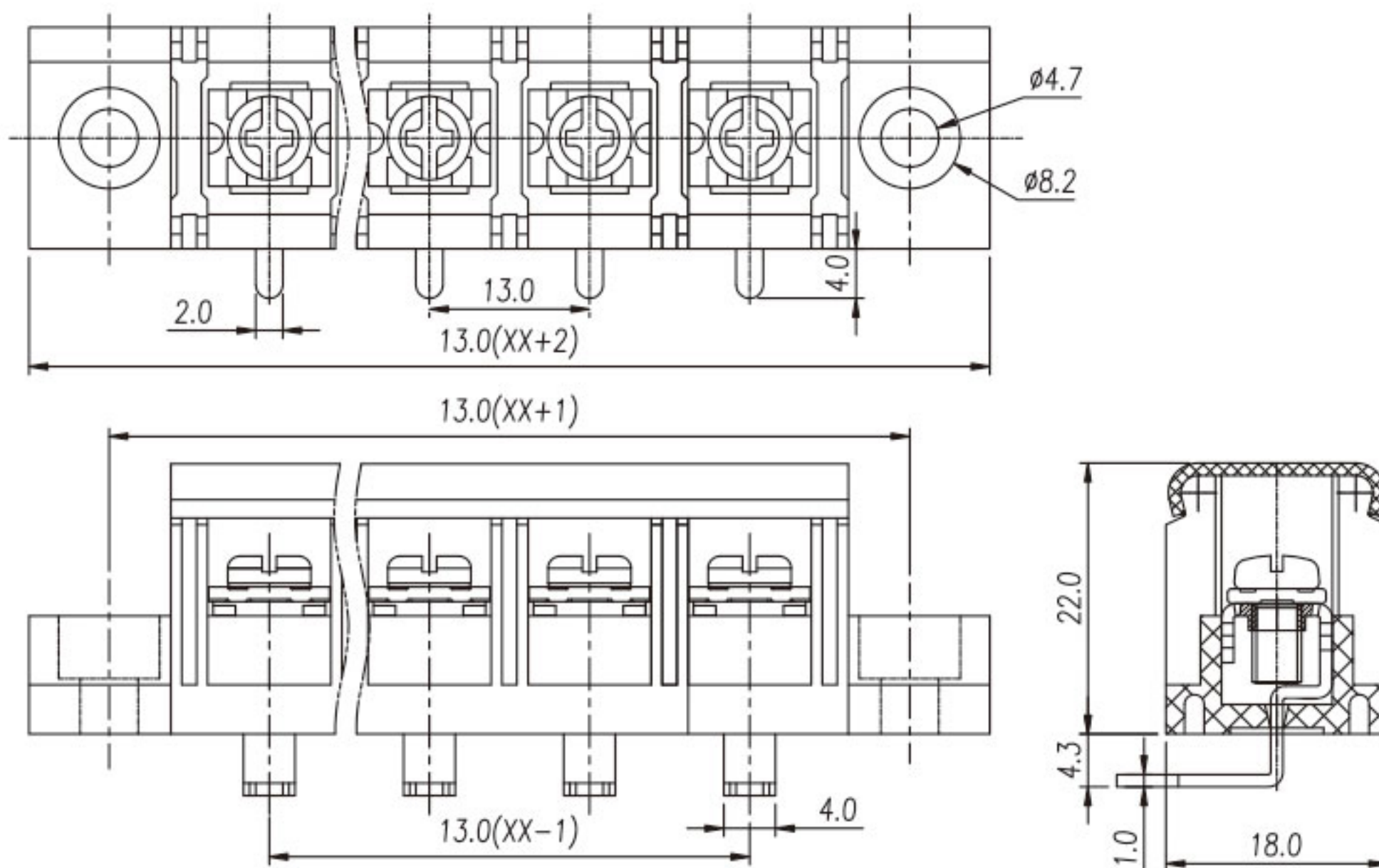

MATERIAL

Screws	M4.0 Steel Ni plated
Pin Header	Brass, Sn plated
Housing	PA66, UL94V-0

ELECTRICAL

Standard	UL	IEC
Rated voltage	600V	750V
Rated current	40A	41A
Wire range	18-10AWG	6.0mm ²
Contact Resistance	20m Ω	
Insulation resistance	500M Ω /DC500V	
Withstanding voltage	AC2000V/1Min	
Temp. range	-40°C~+105°C	
Torque	12.24kgf-cm/1.2Nm/10.6Lbin	